

The marking on this product doesn't contain environmental hazardous materials per directive 2011/65/EU for RoHS compliant.

NOTE:

1. ELECTRICAL AND MECHANICAL PERFORMANCE SHOULD MEET THE SAS3.0 INDUSTRIAL STANDAND.
电气和机械特性遵循SAS3.0工业标准。
2. HE CABLE ASSEMBLY SHOULD BE RoHS2.0 COMPLIANT.
该产品通过RoHS2.0认证。

REVISIONS

ECN NO.	REV.	DESCRIPTIONS	CHECKED	APPROVED	DATE
REL.	AX4	ADD EXPANDO TUBE	JIESS	KASUN	06/28/2017
	AX5	CHANGE LENGTH	ANKER	KASUN	10/17/2017
	AX6	CHANGE LENGTH	ANKER	KASUN	10/18/2017
	AX7	PACK THE CABLE AND ADD KIT P/N	NELSON	KASUN	12/05/2017

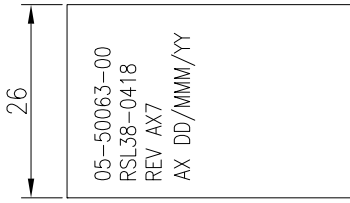
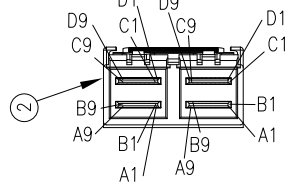
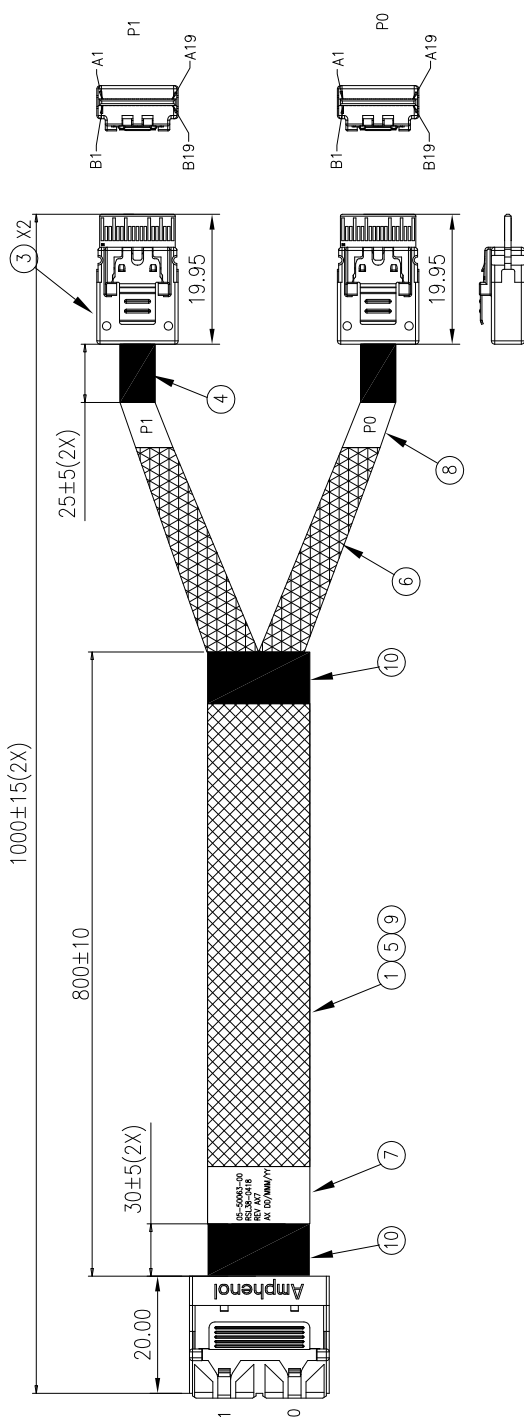

LABEL DETAIL

ITEM	P/N	DESCRIPTION	QTY
10	HMMTP00036	ACETOUS Tape:30mm WIDE,30W/REEL,BLK,HF	A/R
9	T-RMTBD10005	EXPANDO TUB:10MM,PET,GREEN,SINGLE	2
8	HMLS814401	LABEL:14*40MM,WHI,HF	2
7	HMLS870261	LABEL 70*26MM WHITE,R2,HF	1
6	T-HMTBD07002	EXPANDO TUB:7.0MM,GREEN,SINGLE(007~25MM),R2,HF	A/R
5	R15710320X	WIRE,32AWG,U/L1571,OD<=0.45MM	A/R
4	HMMTP00012	TAPE:ACETATE CLOTH INSUL ATION,25MM,BLK	A/R
3	AST8654-0038-07	X4 NARROW SimsSAS 38PIN STRAIGHT PLUG	2
2	AST8643-0072	HD MINI SAS 72POS STR	1
1	T-HWSS320019	SAS CBL:32AWG,LOOSE,1000HM,VW-1,HF,24G	A/R

This drawing is the property of Amphenol Corporation and is delivered on the express condition that it is not to be disclosed, reproduced or used, in whole or in part, for manufacture or sale by anyone other than Amphenol Corporation without its prior consent, and that no right is granted to disclose or use any information in this drawing.

GENERAL TOLERANCES	
.X:	± 0.5
.XX:	± 0.3
.XXX:	± 0.01
ANGULAR:	± 1°

DRAWN:	NATHAN CAO	DATE:	12/05/2017
CHECKED:	NELSON WANG	DATE:	12/05/2017
APPROVED:	KASUN LI	DATE:	12/05/2017
DWG. No.:		RSL38-0418	
SCALE:		NONE	
UNIT:		MM	
SIZE:		A4	
REV.:		AX7	
SHEET		1 OF 4	

Amphenol

ASSEMBLETECH Co. LTD.

TITLE:
HD MINISAS 72P TO 2X SLIMLINE 38P CABLE ASSEMBLY

The marking on this product doesn't contain environmental hazardous materials per directive 2011/65/EU for RoHS compliant.

REVISIONS

ECN NO.	REV.	DESCRIPTIONS	CHECKED	APPROVED	DATE
REL.					

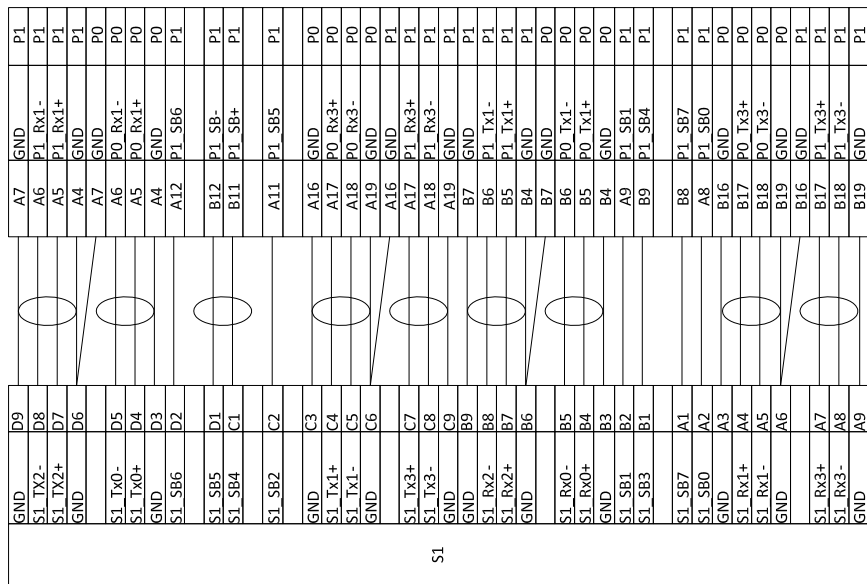
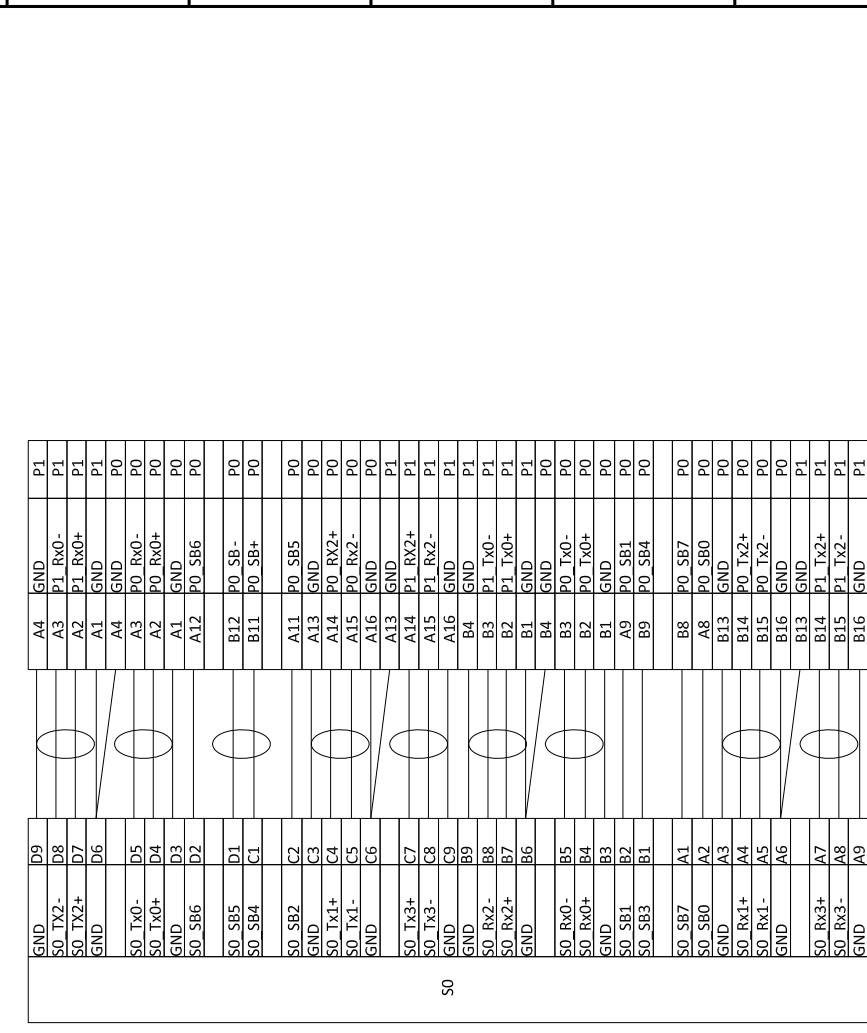

NOTE:
Special wire diagram , pay attention to the corresponding relationship.
线位特殊, 要注意对应关系.

Amphenol
ASSEMBLETECH Co. LTD.

TITLE: HD MINISAS 72P TO 2X SLIMLINE 38P CABLE ASSEMBLY

DWG. No.: RSL38-0418

SCALE: NONE

UNIT: MM

SIZE: A4

SHEET 2 OF 4

REV.: AX7

DATE: 12/05/2017

DRAWN: NATHAN CAO

CHECKED: NELSON WANG

APPROVED: KASUN LI

GENERAL TOLERANCES

.X: ± 0.5

.XX: ± 0.3

.XXX: ± 0.01

ANGULAR: ± 1°

The marking on this product doesn't contain environmental hazardous materials per directive 2011/65/EU for RoHS compliant.

BOX ID LABEL

WYYWW+SSSSS
 BOX ID: [Barcode]
 Revision: A
 Avago Part Number: 05-50063-00
 U.2 Enabler Cable, Mini SAS HD (x8) to 2 x4 SlimLine, 1.0M
 Quantity/Cartons: [Barcode]
 Date Packed: MM/DD/YY
 Batch Number: ZWYY0000X
 [Barcode]

100
75

BARCODE READING: WYYWW+SSSSS
 NOTES:
 YY=SHIPMENT YEAR
 WW=SHIPMENT WEEK
 SSSSS=每周流水码由CSK在出货前一天提供给产线打印标签

BARCODE READING: 05-50063-00

BARCODE READING: XX
 BARCODE READING: MMDDYY
 NOTES:
 MM=MONTH OF MANUFACTURE
 DD=DATE OF MANUFACTURE
 YY=YEAR OF MANUFACTURE
 YYY0000X=每周流水码由CSK在出货前一天提供给产线打印标签

(PE BAG LABEL CENTRALLY LOCATED)

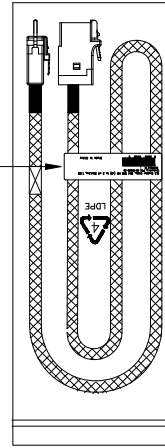

PACKAGE

LABEL 6

CODE TYPE: UPC CODE
 BARCODE READING: 830343007325

LABEL 3

U.2 Enabler Cable, Mini SAS HD (x8) to 2 x4 SlimLine, 1.0M
 Ordering P/N: 05-50063-00
 Marketing ID :
 [Barcode]
 8 30343 00732 5
 Made in China

REVISIONS

ECN NO.	REV.	DESCRIPTIONS	CHECKED	APPROVED	DATE
REL.					

Amphenol ASSEMBLETECH Co. LTD.

This drawing is the property of Amphenol Corporation and is delivered on the express condition that it is not to be disclosed, reproduced or used, in whole or in part, for manufacture or sale by anyone other than Amphenol Corporation without its prior consent, and that no right is granted to disclose or use any information in this drawing.

GENERAL TOLERANCES	TITLE: HD MINISAS 72P TO 2X SLIMLINE 38P CABLE ASSEMBLY	
.X: ± 0.5	DRAWN: NATHAN CAO	DATE: 12/05/2017
.XX: ± 0.3	CHECKED: NELSON WANG	DATE: 12/05/2017
.XXX: ± 0.01	APPROVED: KASUN LI	DATE: 12/05/2017
ANGULAR: ± 1°	DWG. No.: RSL38-0418	SCALE: NONE UNIT: MM SIZE: A4
		SHEET 3 OF 4 REV.: AX7

The marking on this product doesn't contain environmental hazardous materials per directive 2011/65/EU for RoHS compliant.

100

From: Avago Technologies Trading LTD
 1/A, Amphard, Kuantan (Tech. (Kuantan)) Co., Ltd
 39-B, Jalan P1, Industrial Estate, Kuantan, Terengganu, China

Ship To: Avago Technologies International Sales Pte. Limited
 4/A, Avago Technologies (Malaysia) Sdn Bhd (REGISRM)
 P10, 3155, Persiaran Cempaka Sentosa 4, Mukim, 13, Skudai, Johor
 Taman Perindustrian Batu Kawan, 14110 Pulau Pinang, Bandar Cassia, Malaysia

(3s) Packing ID: WYWW+SSSSS
 XXXXXXXXXXXX

(K) Purchase Order: XXXXXXXXXXXX

(2K) Delivery No:

(P) Customer Part Number:

(1P) Avago Part Number: 05-50063-00 (2P) Revision:

(4L) Country of Origin: CN

(Q) Quantity: XX

Description: U,2 Enabler Cable, Mini SAS HD (x8) to 2 x4 SlimLine, 1.0M
 (9D) Package Date: YYYW

(1T) Batch Number: ZWY0000X
 Package Count: X of Y
 Package Weight: XX Kg

Ship to: 地址由CSR在出货前一天提供
 产线打印标签

BARCODE REDDING: WYWW+SSSSS
 NOTES: YY=SHIPMENT YEAR
 WW=SHIPMENT WEEK

SSSSS=每周流水码由CSR在出货前一天提供
 产线打印标签

BARCODE REDDING: XXXXXXXXXXXX

BARCODE REDDING: A

BARCODE REDDING: CN

BARCODE REDDING: YYYW
 NOTES: YY=SHIPMENT YEAR
 WW=SHIPMENT WEEK

BARCODE REDDING: ZWY0000X
 NOTES: YY=SHIPMENT YEAR
 X=EVERYDAY CUSTOMER(H=1206)
 Out-going PRODUCT NUMBER
 Y0000X=每周流水码由CSR在出货前一天提供
 产线打印标签

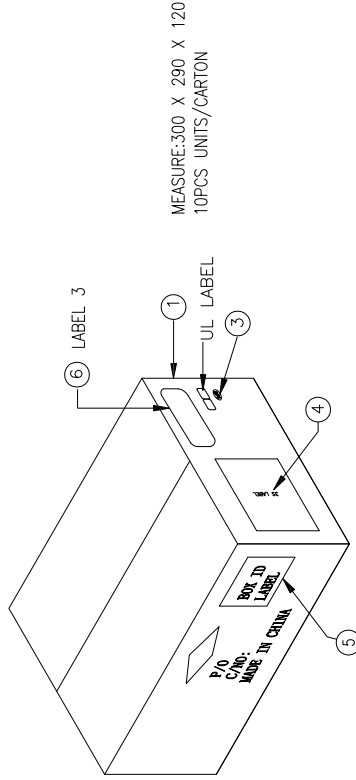
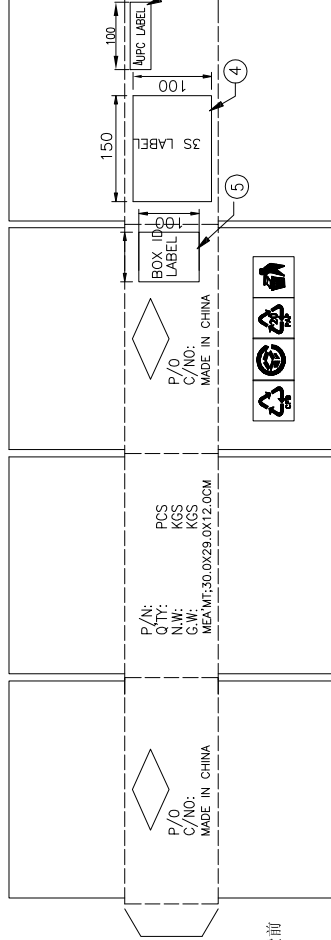
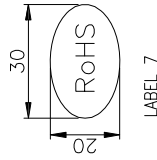

MEASURE: 300 X 290 X 120
 10PCS UNITS/CARTON

6	RMLS00401	LABEL3:100*40MM,WHIT,BLANK,R2	2
5	RMLS010075	BOX ID LABEL:100MM*75MM,WHIT,BLANK, LABEL6 INFO	1
4	RMLS004062	3S LABEL:150MM*100MM,WHITE,R2,LABEL4 INFO	1
3	RMLS030201	RoHS LABEL:20*30MM, LABEL7 INFO	1
2	RMBZIP0046	ZIP BAG:280*100MM	1
1	RMBCTN0049	CARTON:300*290*120MM	1
ITEM	PART NUMBER	DESCRIPTION	QTY

Amphenol

ASSEMBLETECH Co. LTD.

TITLE:

HD MINISAS 72P TO 2X SLIMLINE 38P CABLE ASSEMBLY

DRAWN:	NATHAN CAO	DATE:	12/05/2017
CHECKED:	NELSON WANG	DATE:	12/05/2017
APPROVED:	KASUN LI	DATE:	12/05/2017

DWG. No.: RSL38-0418

SCALE: NONE

UNIT: MM

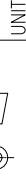

SIZE: A4

SHEET 4 OF 4

REV.: AX7

REVISIONS

ECN NO.	REV.	DESCRIPTIONS	CHECKED	APPROVED	DATE
REL.					